



**BERLI**<sup>®</sup>  
MACCHINE AGRICOLE

**TA/K  
TA/LI  
TA/L**



**Trinciargini per trattori da 20 a 60 HP**



**In-line and offset mulchers for tractors from 20 to 60 HP**



**Böschungsmulcher für traktoren von 20 bis 60 PS**



**Broyeurs multifonctions pour tracteurs de 20 a 60 CV**



**Trituradoras de laderas para tractores de 20 a 60 CV**



L'esperienza di oltre 50 anni nel settore delle macchine agricole permette alla ditta Berti di offrire alla sua vasta clientela una gamma completa di attrezzature tecnologicamente avanzate al servizio di un'agricoltura sempre più esigente e specializzata. La qualità dei prodotti fin dalla materia prima, la volontà di soddisfare sempre e prima di tutto le esigenze della clientela, la robustezza, l'affidabilità, hanno dato vita al largo consenso che queste macchine hanno ricevuto in tutto il mondo.



The experience of over 50 years in the manufacturing of farm implements makes it possible for Berti Company to offer a complete range of technologically advanced mulchers and shredders, to serve a more and more demanding and specialized agriculture.

The high quality, the sturdiness and the reliability of the products, the will to satisfy always the customer's requirement are the reasons of the large success enjoyed by these implements worldwide.







Die Firma Berti ha über 50 Jahre Erfahrung auf dem Gebiet der Landwirtschaftsmaschinen und ist also imstande, ihren zahlreichen Kunden eine komplette Palette von technologisch fortgeschrittenen Landwirtschaftsausrüstungen zu Verfügung zu stellen.

Die Produktqualität, gekennzeichnet durch die Wahl von Rohstoffen erster Klasse, die Beständigkeit und die Zuverlässigkeit der Maschinen, hat die Firma in die Lage gesetzt, diese in der ganzen Welt einzusetzen.

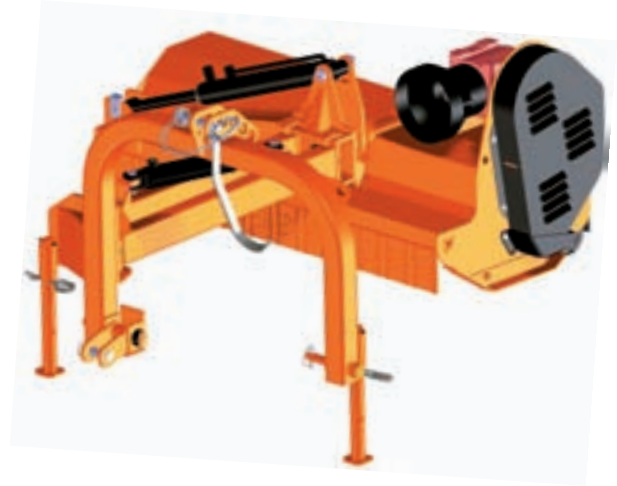

L'expérience acquise au cours de plus de 50 ans dans le monde de la machine agricole permet à la firme Berti d'offrir à ses nombreux clients une gamme complète d'équipements technologiquement à l'avant-garde au service d'une agriculture exigeante et professionnelle. La qualité des produits à partir de la matière première, la volonté de satisfaire surtout les exigences de la clientèle, la résistance et la fiabilité ont permis à nos machines d'obtenir un accueil très favorable dans le monde entier.



La experiencia de más de 50 años en el sector de las máquinas agrícolas ha permitido a la empresa Berti ofrecer a sus clientes una gama completa de equipos tecnológicamente avanzados para una agricultura cada vez más especializada. Gracias a la robustez y a la fiabilidad de los productos y a una calidad que se busca incluso en las materias primas empleadas, unido a la voluntad de satisfacer siempre y en primer lugar las exigencia de los clientes, Berti se ha hecho famosa en todo el mundo.

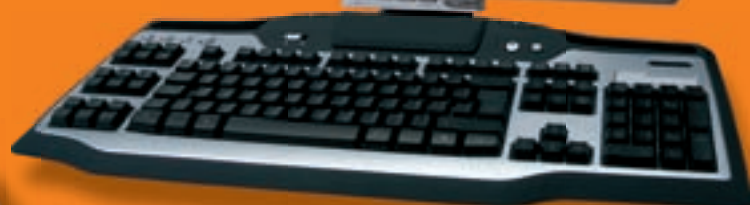
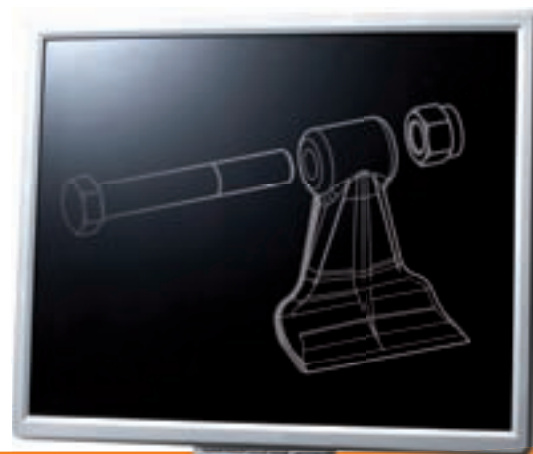

# TA/K





- Valvola di sicurezza.
- Safety valve.
- Sicherheitsventil.
- Soupape de sûreté.
- Válvula de seguridad.

- Sistema antiurto meccanico.
- Mechanical breakaway device.
- Mechanische Ahfahrsicherung.
- Dispositif de sécurité mécanique.
- Dispositivo mecánico de seguridad.

- Protezione carter.
- Side-protection.
- Seitenschutz.
- Protection du carter.
- Protección del cárter de la transmisión.

 Trinciatrice compatta multiuso, da applicare a trattori con potenza compresa tra 20 e 45 HP. Adatta a lavorare sia posteriormente che lateralmente al trattore. E' consigliata per erba, residui vegetali, ceppugli e sarmenti di  $\varnothing$  2 cm. Ideale per la pulizia di parchi, aree verdi, giardini, bordi di strade, su fossati, argini e terreni inclinati in genere.







 Broyeur d'accotement multifonctions pour broyer l'herbe, les déchets végétaux, les buissons et les sarments allant jusqu'à  $\varnothing$  2 cm, indiqué pour tracteurs de 20 à 45 CV. Il est idéal pour le nettoyage des espaces verts, des jardins, des rebords des routes, des fossés, des digues et des terrains inclinés.

 Offset / in-line mulcher for grass, residue of vegetables, bushes and pruning up to  $\varnothing$  2 cm, suited for tractors from 20 to 45 HP. Ideal for clearing green areas, gardens, slopes, ditches, banks of watercourses, road side banks.

 Desbrozadora indicada para la trituración de hierba, residuos vegetales, arbustos y restos de poda (hasta 2 cm  $\varnothing$ ), para tractores de 20 a 45 CV. Ideal para parques, áreas verdes, jardines, cunetas y terrenos en pendiente en general.

 Universalgerät für Heckanbau, für seitliches Mulchen oder hinter dem Schlepper für Gras, Vegetation, Reisig und Äste bis  $\varnothing$  2 cm für Randstreifen, für Wassergräben und Böschungen, für Traktoren von 20 bis 45 PS.

*Il trattore deve essere dotato di almeno n.2 prese d'olio a doppio effetto / The tractor has to be equipped with n. 2 double effect oil plugs / Der Traktor muss mit 2 doppelwirkenden Hydraulikanschlüssen ausgestattet sein / Le tracteur doit être équipé avec au moins 2 prises d'huile à double effet / El tractor deberá estar equipado con al menos dos enchufes hidráulicos con válvula de doble efecto.*

Mod.													
	cm	Min	Max	n°	n°	n°	PTO	A	B	C	D	E	ca. (*)
<b>TA/K 115</b>	115	20	45	32	64	2	540	115	115	60	175	100	280
<b>TA/K 125</b>	125	25	45	34	68	2	540	125	120	60	185	110	295
<b>TA/K 145</b>	145	25	45	40	80	2	540	145	120	60	205	130	320

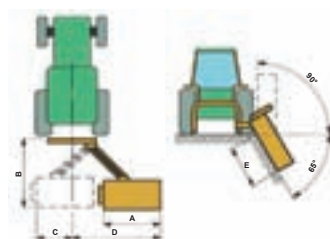

\* Il peso è riferito alla macchina standard (senza accessori) • The weight refers to the machine with standard equipment (without accessories) • Die Gewichtsangabe bezieht sich auf die Maschine in Grundausstattung (ohne Sonderausstattung) • Le poids se réfère à la machine standard (sans accessoires) • El peso se refiere al estándar de la máquina (sin accesorios).



- Sistema flottante con limitatore.
- Floating device, with limiter.
- Schwimmstellung-System mit Hubbegrenzer.
- Système flottante avec limiteur.
- Sistema de enganche flotante con limitador.

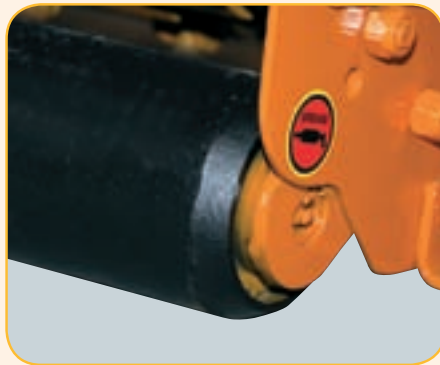

- Rullo livellatore posteriore autopulente, regolabile in altezza.
- Height adjustable self-cleaning levelling roller.
- Einstellbare und selbstreinigende Stützwalze.
- Rouleau palpeur autonettoyant, réglable en hauteur.
- Rodillo trasero autolimpiable y regulable en altura.



- Slitte d'appoggio antiusura.
- Skids of anti-wearing steel.
- Jeu patins anti-usure.
- Satz Kufen mit Anti-Verschleißmaterial.
- Patines de acero reforzado anti-desgaste.



- Tenditore automatico delle cinghie.
- Full automatic belts adjuster.
- Automatische Riemenspannung.
- Tendeur automatique des courroies.
- Tensor automático de las correas.



- Albero cardanico rinforzato.
- Hardened PTO drive shaft.
- Verstärkte Gelenkwelle.
- Cardan à profil renforcé.
- Eje de TDF reforzado.

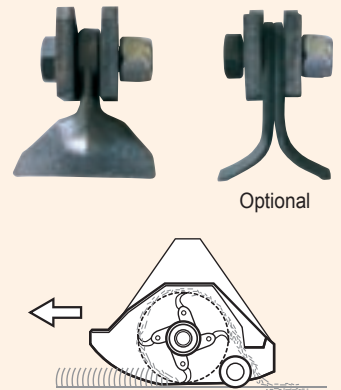

Optional

## OPTIONALS



- Distributore a doppio effetto con leve e cavi flessibili.
- Double effect distributor with levers and with wire-cables.
- Doppelwirkendes Steuerventil mit Hebeln und Bowdenzügen.
- Distributeur double effet à leviers avec téléflexibles en cabine.
- Distribuidor de doble efecto con accionamiento por tele-flexibles.



- Albero cardanico doppio omocinetico.
- Double Wide-Angle drive shaft.
- Doppel-Weitwinkel Gelenkwelle.
- Cardan double homocinétique.
- Cardan doble homocinético.



# TA/LI





- Valvola di sicurezza.
- Safety valve.
- Sicherheitsventil.
- Soupape de sûreté.
- Válvula de seguridad.

- Attacco 3° punto con snodo oscillante.
- 3-point linkage with floating link.
- Dreipunktbock mit Schwimmstellung System.
- Attelage à 3 points avec système flottante.
- Enganche a los tres puntos del tractor con enganche flotante.

- Protezione carter.
- Side-protection.
- Seitenschutz.
- Protection du carter.
- Protección del cárter de la transmisión.

 Trinciatrice compatta multiuso, da applicare a trattori con potenza compresa tra 35 e 60 HP. Adatta a lavorare sia posteriormente che lateralmente al trattore. E' consigliata per erba, residui vegetali, cespugli e sarmenti di ø 2-3 cm., Ideale per la pulizia di parchi, aree verdi, giardini, bordi di strade, su fossati, argini e terreni inclinati in genere.







 Broyeur d'accotement compact multifonctions pour l'herbe, les déchets végétaux, les buissons et les sarments allant jusqu'à ø 2-3 cm, indiqué pour tracteurs de 35 à 60 CV. Il est idéal pour les parcs, les espaces verts, les jardins, le rebord des routes, les fossés, les digues et les terrains inclinés.

 Compact offset / in-line mulcher for grass, residue of vegetables, bushes and pruning up to ø 2-3 cm., suited for tractors from 35 to 60 HP. Ideal for parks, green areas, gardens, slopes, ditches, banks of watercourses.

 Desbrozadora compacta indicada para la trituración de hierba, residuos vegetales, arbustos y restos de poda (hasta 2-3 cm ø), para tractores de 35 a 60 CV. Ideal para parques, áreas verdes, jardines, cunetas y terrenos en pendiente en general.

 Heck- und Seitenmulcher für Gras, Vegetation, Reisig und Äste bis ø 2-3 cm. für Traktoren von 35 bis 60 PS. Es eignet sich für Parks, Garten, Wiesen, Böschungen und Wassergräben.

*Il trattore deve essere dotato di almeno n.2 prese d'olio a doppio effetto / The tractor has to be equipped with n. 2 double effect oil plugs / Der Traktor muss mit 2 doppelwirkenden Hydraulikanschlüssen ausgestattet sein / Le tracteur doit être équipé avec au moins 2 prises d'huile à double effet / El tractor deberá estar equipado con al menos dos enchufes hidráulicos con válvula de doble efecto.*

Mod.													
	cm	Min	Max	n°	n°	n°	PTO	A	B	C	D	E	ca. (*)
	cm	HP	HP					cm	cm	cm	cm	cm	Kg
<b>TA/LI 135</b>	135	35	60	12	36	3	540	135	154	60	210	120	380
<b>TA/LI 145</b>	145	35	60	14	42	3	540	145	154	60	220	130	400
<b>TA/LI 160</b>	160	35	60	14	42	3	540	160	154	60	235	145	440

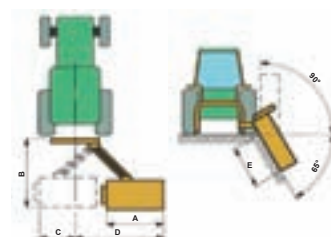

\* Il peso è riferito alla macchina standard (senza accessori) • The weight refers to the machine with standard equipment (without accessories) • Die Gewichtsangabe bezieht sich auf die Maschine in Grundausstattung (ohne Sonderausstattung) • Le poids se réfère à la machine standard (sans accessoires) • El peso se refiere al estándar de la máquina (sin accesorios).



- Sistema flottante con limitatore.
- Floating device, with limiter.
- Schwimmstellung-System mit Hubbegrenzer.
- Système flottante avec limiteur.
- Sistema de enganche flotante con limitador.

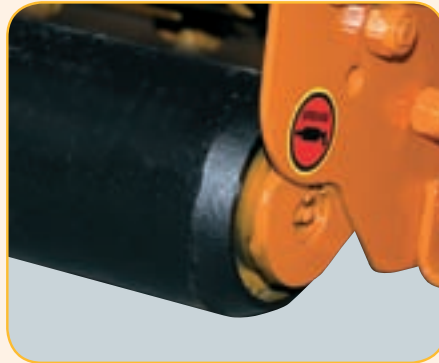

- Rullo livellatore posteriore autopulente, regolabile in altezza.
- Height adjustable self-cleaning levelling roller.
- Einstellbare und selbstreinigende Stützwalze.
- Rouleau palpeur autonettoyant, réglable en hauteur.
- Rodillo trasero autolimpiable y regulable en altura.

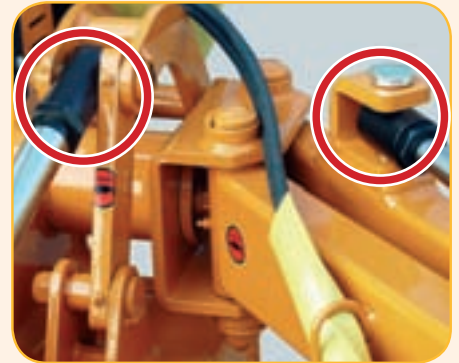

- Martinetti regolabili.
- Adjustable cylinders.
- Einstellbare hydr. Zylindern.
- Vérins réglables.
- Cilindros hidráulicos con extensión ajustable.



- Albero cardanico rinforzato.
- Hardened PTO drive shaft.
- Verstärkte Gelenkwelle.
- Cardan à profil renforcé.
- Eje de TDF reforzado.



Optional

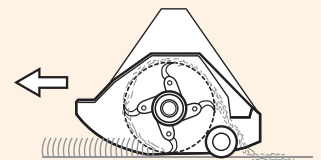

## OPTIONALS



- Sistema antishock BERTI\*.
- Exclusive BERTI Anti-Shock Device\*.
- Anti-Schock System BERTI\*.
- Système antichoc exclusif BERTI\*.
- Dispositivo antichoque exclusivo de Berti\*.



- Slitte d'appoggio antiusura.
- Skids of anti-wearing steel.
- Satz Kufen mit Anti-Verschleißmaterial.
- Jeu patins anti-usure.
- Patines de acero reforzado anti-desgaste.



- Albero cardanico doppio omocinetico.
- Double Wide-Angle drive shaft.
- Doppel-Weitwinkel Gelenkwelle.
- Cardan double homocinétique.
- Cardan doble homocinético.

# TA/L

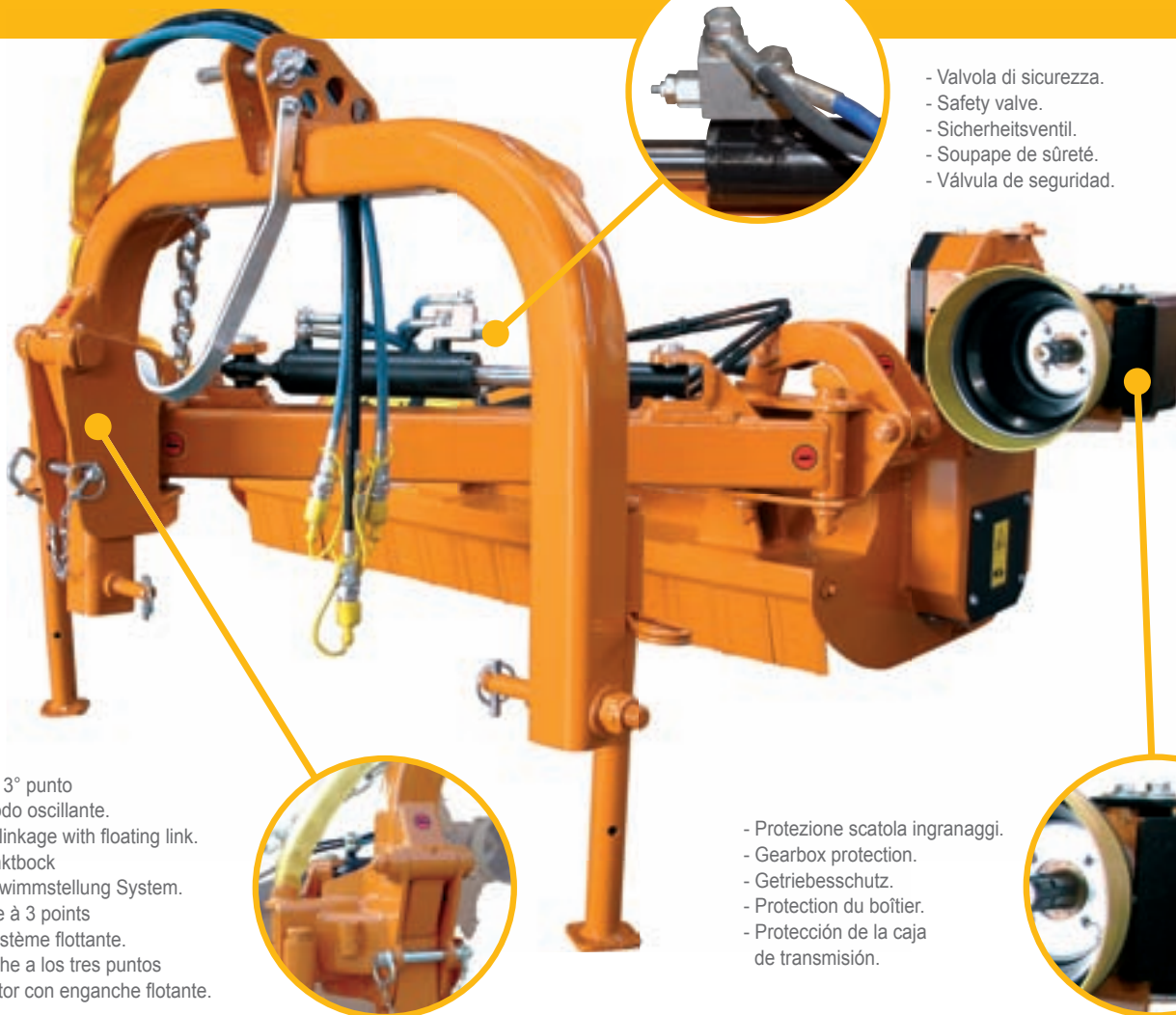



- Valvola di sicurezza.
- Safety valve.
- Sicherheitsventil.
- Soupape de sûreté.
- Válvula de seguridad.

- Attacco 3° punto con snodo oscillante.
- 3-point linkage with floating link.
- Dreipunktbock mit Schwimmstellung System.
- Attelage à 3 points avec système flottante.
- Enganche a los tres puntos del tractor con enganche flotante.

- Protezione scatola ingranaggi.
- Gearbox protection.
- Getriebeschutz.
- Protection du boîtier.
- Protección de la caja de transmisión.

 Trinciatrice compatta multiuso, da applicare a trattori con potenza compresa tra 35 e 60 HP. Adatta a lavorare sia posteriormente che lateralmente al trattore. E' consigliata per erba, residui vegetali, cespugli e sarmenti di ø 2-3 cm., Ideale per la pulizia di parchi, aree verdi, giardini, bordi di strade, su fossati, argini e terreni inclinati in genere.







 Compact offset / in-line mulcher for grass, residue of vegetables, bushes and pruning up to ø 2-3 cm., suited for tractors from 35 to 60 HP. Ideal for parks, green areas, gardens, slopes, ditches, banks of watercourses.

 Heck und Seitenmulcher für Gras, Vegetation, Reisig und Ästen bis ø 2-3 cm. für Traktoren von 35 bis 60 PS. Es eignet sich für Parks, Garten, Wiesen, Böschungen und Wassergräben.

 Broyeur d'acotement compact multifonctions pour broyer l'herbe, les déchets végétaux, les buissons et les sarments allant jusqu'à ø 2-3 cm, indiqué pour tracteurs de 35 à 60 CV. Il est idéal pour les parcs, les espaces verts, les jardins, le rebord des routes, les fossés, les digues et les terrains inclinés.

 Desbrozadora compacta indicada para la trituración de hierba, residuos vegetales, arbustos y restos de poda (hasta 2-3 cm ø), para tractores de 35 a 60 CV. Ideal para parques, áreas verdes, jardines, cunetas y terrenos en pendiente en general.

*Il trattore deve essere dotato di almeno n.2 prese d'olio a doppio effetto / The tractor has to be equipped with n. 2 double effect oil plugs / Der Traktor muss mit 2 doppelwirkenden Hydraulikanschlüssen ausgestattet sein / Le tracteur doit être équipé avec au moins 2 prises d'huile à double effet / El tractor deberá estar equipado con al menos dos enchufes hidráulicos con válvula de doble efecto.*

Mod.													
	cm	Min					Max	n°	n°	n°	PTO		A
<b>TA/L 115</b>	115	35	60	10	30	3	540	115	154	21	220	115	395
<b>TA/L 135</b>	135	35	60	12	36	3	540	135	154	21	240	135	425
<b>TA/L 145</b>	145	35	60	14	42	3	540	145	154	21	259	145	450

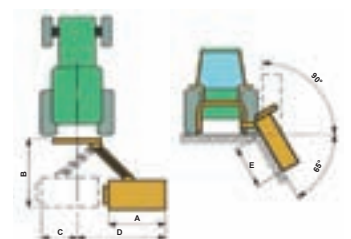

\* Il peso è riferito alla macchina standard (senza accessori) • The weight refers to the machine with standard equipment (without accessories) • Die Gewichtsangabe bezieht sich auf die Maschine in Grundausstattung (ohne Sonderausstattung) • Le poids se réfère à la machine standard (sans accessoires) • El peso se refiere al estándar de la máquina (sin accesorios).





- Sistema flottante con limitatore.
- Floating device, with limiter.
- Schwimmstellung-System mit Hubbegrenzer.
- Système flottante avec limiteur.
- Sistema de enganche flotante con limitador.



- Rullo livellatore posteriore autopulente, regolabile in altezza.
- Height adjustable self-cleaning levelling roller.
- Einstellbare und selbstreinigende Stützwalze.
- Rouleau palpeur autonettoyant, réglable en hauteur.
- Rodillo trasero autolimpiable y regulable en altura.

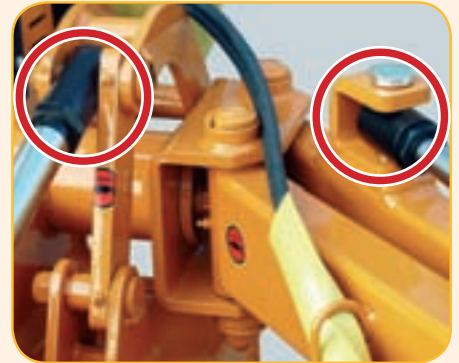

- Martinetti regolabili.
- Adjustable cylinders.
- Einstellbare hydr. Zylindern.
- Vérins réglables.
- Cilindros hidráulicos con extensión ajustable.



- Albero cardanico rinforzato.
- Hardened PTO drive shaft.
- Verstärkte Gelenkwelle.
- Cardan à profil renforcé.
- Eje de TDF reforzado.



Optional

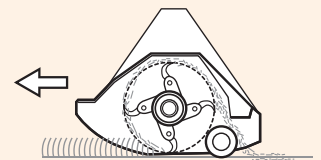

## OPTIONALS



- Sistema antishock BERTI\*.
- Exclusive BERTI Anti-Shock Device\*.
- Anti-Schock System BERTI\*.
- Système antichoc exclusif BERTI\*.
- Dispositivo antichoque exclusivo de Berti\*.



- Slitte d'appoggio antiusura.
- Skids of anti-wearing steel.
- Satz Kufen mit Anti-Verschleißmaterial.
- Jeu patins anti-usure.
- Patines de acero reforzado anti-desgaste.



- Albero cardanico doppio omocinetico.
- Double Wide-Angle drive shaft.
- Doppel-Weitwinkel Gelenkwelle.
- Cardan double homocinétique.
- Cardan doble homocinético.



TA/K



TA/LI





TA/L



**\*ANTI-SHOCK BERTI**

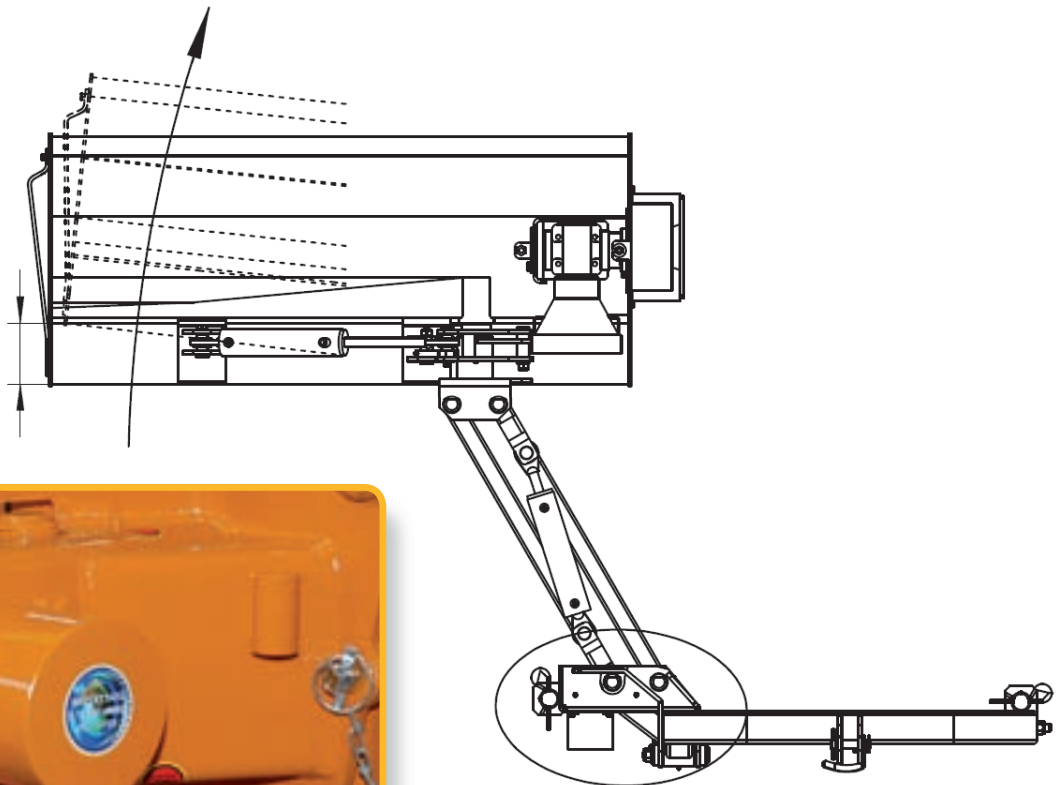

www.bertima.it



Le illustrazioni e i dati del presente catalogo sono indicative e non vincolanti per il costruttore. • All pictures and data above are indicative only and not binding for the manufacturer. • Alle in diesem Katalog enthaltenen Angaben und Zeichnungen sind annahmend und unverbindlich. • Toutes les données insérées dans ce catalogue ont été indiquées seulement à titre de renseignement. • Las fotografías y los datos mostrados son meramente indicativos y podrían ser variados sin previo aviso por el fabricante.



**BERTI**<sup>®</sup>  
MACCHINE AGRICOLE



Via Musi, 1/A-3 - 37042 Caldiero (VR) ITALY  
Tel. +39.045.6139711 - Fax +39.045.6150251  
info@bertima.it



 MADE IN ITALY

D004.11